



## Vector Signal Generator R&S SMIQ03HD

### Dedicated to 3GPP

**Supplement to  
Vector Signal Generator R&S SMIQ  
(see data sheet PD 0757.2438)**

- ◆ Wide dynamic range: ACLR 70 dB typ. for 3GPP test model 1, 64 DPCH
- ◆ Single-carrier scenarios, enhanced features with option R&S SMIQB57 (3GPP downlink)
  - Further improvement of ACLR (77 dB typ.)
  - High output power (up to +30 dBm PEP)
- ◆ Multicarrier scenarios: integrated baseband filters to improve ACLR of 1 to 4 WCDMA carriers
- ◆ Short frequency and level setting time
- ◆ Optional fading simulator (R&S SMIQB 14/B 15) and noise generator/distortion simulator (R&S SMIQB 17)

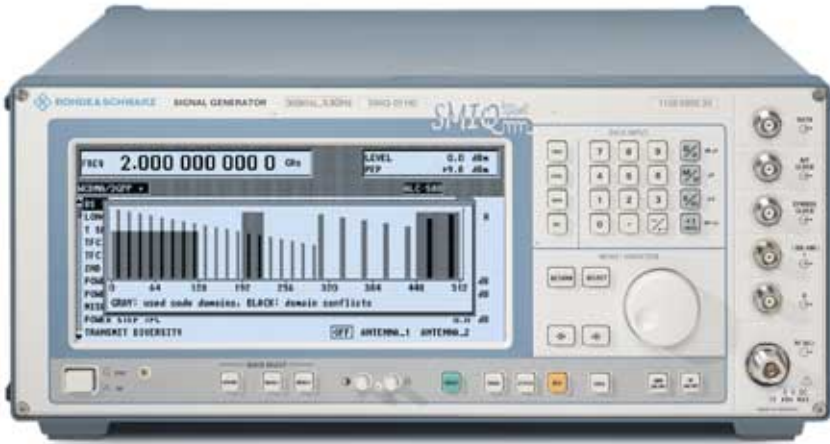

The third-generation mobile radio standards use broadband transmission methods to allow the configuration of communication networks with high data rates. WCDMA with its bandwidth of 3.84 MHz and the underlying CDMA method places particularly stringent requirements on the total transmission chain.

The signal statistics of a WCDMA signal reveal high crest factors (peak-to-average power ratios). Therefore, amplifiers with a wide linear range are required to ensure distortion-free transmission not only of average transmit power but also of high power peaks.

The requirements on base station power amplifiers become even more stringent since the amplifiers also transmit multicarrier signals within the 60 MHz downlink band. In addition to single-carrier power amplifiers (SCPA), multicarrier power amplifiers (MCPA) are increasingly used. Signal sources featuring wide dynamic range and high accuracy, such as the R&S SMIQ03HD, are required for the development and production testing of the amplifiers. WCDMA specifications allow base stations only a very low adjacent-channel power (ACP). The R&S SMIQ03HD supplies a test signal whose adjacent-channel leakage ratio (ACLR) is much better than the one required for base stations so that measurements can be carried out on amplifiers with sufficient dynamic range.

### Extremely wide dynamic range for WCDMA 3GPP single-carrier signals in the downlink in conjunction with high signal output power

The use of a special filter option (R&S SMIQB57) improves the signal quality of

a WCDMA single-carrier signal in the downlink (2110 MHz to 2170 MHz) regarding adjacent-channel power to a level previously unattained by any signal generator (ACLR 77 dB in adjacent channel and 82 dB in alternate channel). The high output power of the option (up to +30 dBm PEP) is an additional benefit. Additional driver amplifiers for driving the components are not required. This is a great benefit especially for the manufacturers of base station components. Costs are reduced and signal quality is not impaired by the noise of an external amplifier.

If more than one WCDMA carriers are to be generated, several R&S SMIQ03HD signal generators fitted with the R&S SMIQB57 option can be combined

FIG 1: ACLR measurement on single-carrier WCDMA signal (test model 1, 64 DPCH) using R&S SMIQB57

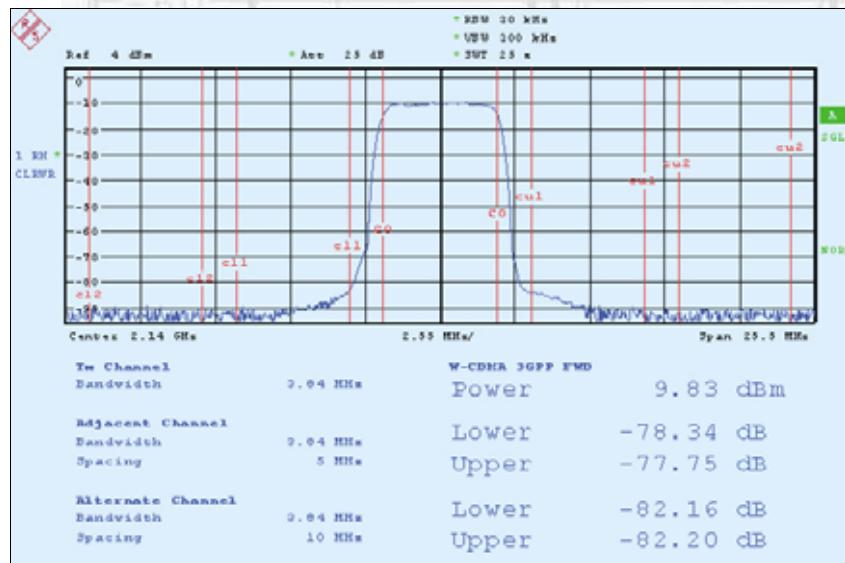
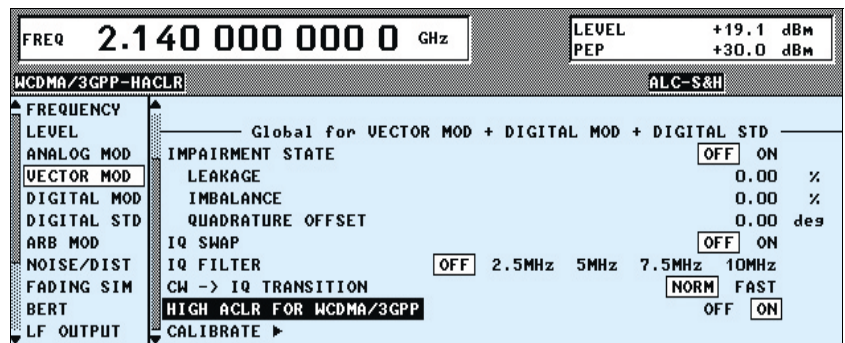

FIG 2: Special mode for high ACLR



to provide a multicarrier scenario of highest spectral purity.

Multicarrier scenarios can also be generated less elaborately using one signal generator only.

**Wide dynamic range for single-carrier and multicarrier signals through integrated baseband filters for highest ALCR at 1 to 4 WCDMA carriers**

Multicarrier signals can be generated by the R&S SMIQ03HD with optionally integrated Arbitrary Waveform Generator R&SSMIQB60, or by the R&S SMIQ03HD in combination with the I/Q Modulation Generator R&S AMIQ. The WCDMA multicarrier signals are calculated with the aid of the user-configurable R&S WinQSIM™ Software that is available free of charge, and transferred to the arbitrary waveform generators. For each of the four scenarios (1 to 4 carriers), an I/Q filter (integrated as standard) with a cut-off frequency of 2.5 MHz, 5 MHz, 7.5 MHz or 10 MHz is switched on. Optimum ALCR values are thus obtained for each of the four possible carrier scenarios.

**Short setting time for level and frequency**

For cost-effective production, a high throughput of modules or devices is required. With its extremely short setting times (frequency/level setting time:

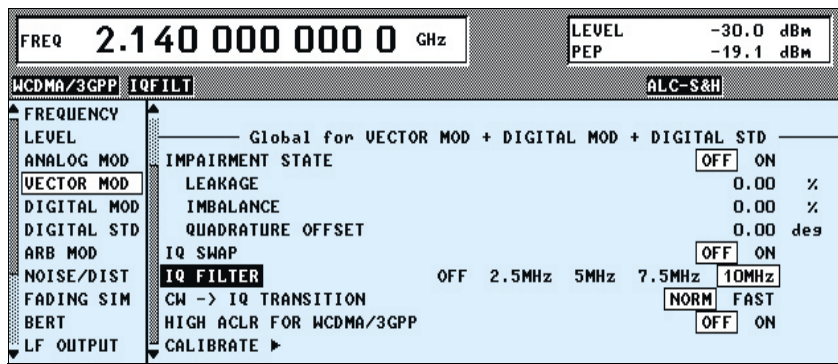

FIG 3: Four different I/Q filters allow ALCR performance of single-carrier to four-carrier WCDMA signals to be optimized

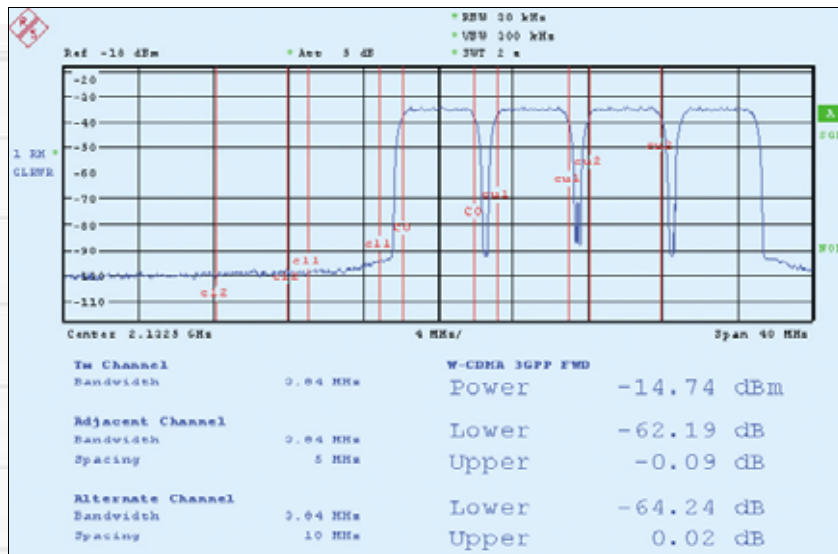

FIG 4: ALCR measurement on four-carrier signal (signal generated by a single R&S SMIQ03HD)

<3 ms/<2.5 ms) the R&S SMIQ03HD easily meets this requirement. Setting times can be further reduced in special modes (List mode: <500 μs, Fast Restore mode: <800 μs).



**Optional fading simulator or noise generator/distortion simulator**



For universal applications of the R&S SMIQ03HD, fading simulators (R&S SMIQB14/B15) and a noise generator/distortion simulator (R&S SMIQB17) can be used to generate realistic signals. The Vector Signal Generators R&S SMIQ are the only generators on the market that can be equipped with internal fading simulators (one-box solution). Moreover, it is possible to use an additional option (R&S SMIQB49) for generating 3G fading scenarios (dynamic fading, 3GPP TS 25.141) for performance tests.

Further information about these options can be found in the R&S SMIQ data sheet.



## Recommended equipment configurations for SCPA/MCPA applications

SCPA	Description	Type	Order No.
<b>Internal baseband generation</b> 	Vector Signal Generator	R&S SMIQ03HD	1125.5555.33
	Modulation Coder	R&S SMIQB20	1125.5190.02
	Data Generator	R&S SMIQB11	1805.4502.04
	Digital Standard WCDMA 3GPP FDD	R&S SMIQB45 <sup>1)</sup>	1104.8232.02
	High ACLR for WCDMA 3GPP (2110 MHz to 2170 MHz)	R&S SMIQB57	1105.1831.02
<b>Ext. baseband generation (e.g. using R&amp;S AMIQ)</b> 	Vector Signal Generator	R&S SMIQ03HD	1125.5555.33
	High ACLR for WCDMA 3GPP (2110 MHz to 2170 MHz)	R&S SMIQB57	1105.1831.02
	I/Q Modulation Generator, incl. R&S WinIQSIM™	R&S AMIQ	1110.2003.03 1110.2003.04

MCPA	Description	Type (multicarrier signals with one R&S SMIQ03HD)	Type (multicarrier signals with two or more R&S SMIQ03HD externally combined)	Order No.
<b>Internal baseband generation</b> 	Vector Signal Generator	R&S SMIQ03HD	R&S SMIQ03HD	1125.5555.33
	Modulation Coder	R&S SMIQB20	R&S SMIQB20	1125.5190.02
	Data Generator	R&S SMIQB11	R&S SMIQB11	1805.4502.04
	Digital Standard WCDMA 3GPP FDD	–	R&S SMIQB45 <sup>1)</sup>	1104.8232.02
	High ACLR for WCDMA 3GPP (2110 MHz to 2170 MHz)	–	R&S SMIQB57	1105.1831.02
	Arbitrary Waveform Generator incl. R&S WinIQSIM™	R&S SMIQB60	–	1136.4390.02
<b>Ext. baseband generation (e.g. using R&amp;S AMIQ)</b> 	Vector Signal Generator	R&S SMIQ03HD	R&S SMIQ03HD	1125.5555.33
	I/Q Modulation Generator, incl. R&S WinIQSIM™	R&S AMIQ	R&S AMIQ	1110.2003.03 1110.2003.04

<sup>1)</sup>Alternatively WCDMA 3GPP FDD signals can be generated with the option R&S SMIQB60 (1136.4390.02) and WinIQSIM™

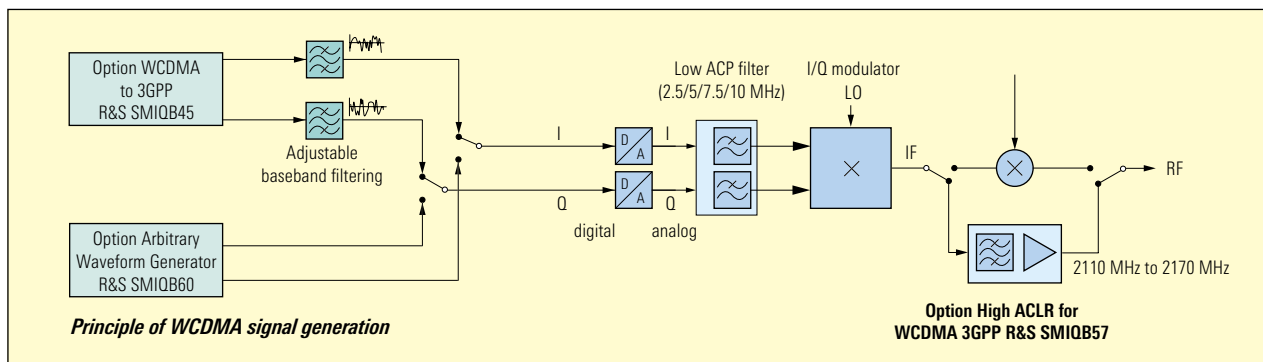



## Specifications

Specifications apply under the following conditions: 30 minutes warmup time at ambient temperature, specified environmental conditions met, calibration cycle adhered to, and total calibration performed. Data designated "overrange" not warranted. For general data please refer to the standard data sheet of the R&S SMIQ (PD 0757.2438). The following data differs from the standard data or refers to additional features.

### Digital Standard WCDMA 3GPP FDD (option R&S SMIQB45)

Single-carrier measurements	
<b>Adjacent-channel leakage ratio, frequency 1850 MHz to 2200 MHz, level <math>\leq 8</math> dBm (PEP)</b>	
1 DPCH (crest factor 5.4 dB, I/Q filter 2.5 MHz) Offset 5 MHz, low-distortion output mode >67 dB, 71 dB typ. Offset 10 MHz, low-noise output mode >73 dB, 76 dB typ.	
Test model 1, 64 DPCH (crest factor 10.6 dB, I/Q filter 2.5 MHz) Offset 5 MHz, low-distortion output mode >66 dB, 70 dB typ. Offset 10 MHz, low-noise output mode >70 dB, 73 dB typ.	

### Multicarrier measurements

<b>Adjacent-channel leakage ratio, frequency 2110 MHz to 2170 MHz, level <math>\leq 8</math> dBm PEP; multicarrier signals generated with the internal Arbitrary Waveform Generator R&amp;S SMIQB60</b>	
2 carriers, test model 1, 64 DPCH (crest factor 11 dB, I/Q filter 5 MHz) Offset 5 MHz, low-distortion output mode >60 dB, 64 dB typ. Offset 10 MHz, low-distortion output mode >65 dB, 68 dB typ.	
3 carriers, test model 1, 64 DPCH (crest factor 11.3 dB, I/Q filter 7.5 MHz) Offset 5 MHz, low-distortion output mode >59 dB, 63 dB typ. Offset 10 MHz, low-distortion output mode >62 dB, 65 dB typ.	
4 carriers, test model 1, 64 DPCH (crest factor 11.8 dB, I/Q filter 10 MHz) Offset 5 MHz, low-distortion output mode >58 dB, 62 dB typ. Offset 10 MHz, low-distortion output mode >61 dB, 64 dB typ.	

### High ACLR<sup>1)</sup> for WCDMA 2110 MHz to 2170 MHz with option R&S SMIQB57

Frequency	
Frequency range	2110 MHz to 2170 MHz
3GPP channel bandwidth	3.84 MHz
Level	
Output level (PEP), normal output mode	-130 dBm to 27 dBm
Overrange	30 dBm
Uninterrupted level setting Attenuator mode fixed	>30 dB
Repeatability ALC STATE ON (CW mode)	0.05 dB typ.
ALC STATE OFF (time interval 5 minutes, temperature interval 5 °C)	<0.15 dB
Linearity error (in displayed level range, attenuator mode fixed)	<0.2 dB over temperature <sup>2)</sup> , 0.1 dB typ.
Total level uncertainty <sup>2)</sup> Attenuator mode auto (-120 dBm to 25 dBm (PEP))	<0.5 dB
CW	<0.7 dB
Digital modulation	<0.7 dB
VSWR, output impedance Level >15 dBm (PEP)	<1.8
Level $\leq 15$ dBm (PEP)	<1.5
Maximal permissible reverse power	1 W
Spectral purity	
Harmonics Level <25 dBm (PEP)	<-30 dBc, -40 dBc typ.
Level <15 dBm (PEP)	<-40 dBc, -50 dBc typ.
Nonharmonics Carrier offset >10 kHz	<-86 dBc
Subharmonics	none
Error vector magnitude (WCDMA, 3.84 Mcps), rms	4% typ.

<sup>1)</sup> ACLR definition according to 3GPP TS 25.141:

Adjacent-channel leakage power ratio is the ratio of the average power centered on the assigned channel frequency to the average power centered on an adjacent channel frequency. In both cases the average power is measured with a filter that has root raised cosine (RRC) filter response with roll-off  $\alpha = 0.22$  and a bandwidth equal to the chip rate.

<sup>2)</sup> The specifications only apply to temperatures from +10 °C to +40 °C.



## Specifications R&S SMIQB57 (continued)

### Adjacent-channel leakage ratio for a single-carrier signal generated with Digital Standard WCDMA 3GPP FDD (option R&S SMIQB45)<sup>2)</sup>

Adjacent-channel leakage ratio 1 DPCH (crest factor 5.4 dB, average power ≤10 dBm) Offset 5 MHz, low-distortion output mode	>75 dB, 78 dB typ.
Offset 10 MHz, low-noise output mode	>81 dB, 84 dB typ.

Adjacent-channel leakage ratio Test model 1, 64 DPCH (crest factor 10.6 dB, average power ≤10 dBm) Offset 5 MHz, low-distortion output mode	>74 dB, 77 dB typ.
Offset 10 MHz, low-noise output mode	>79 dB, 82 dB typ.

## Restrictions on other data when using option R&S SMIQB57

**General:** Modulation bandwidth is reduced to 3GPP channel bandwidth. Due to steep bandpass filtering, additional amplitude and group delay distortions occur.

Topic concerned	Remark
– Broadband amplitude modulation	–
– Digital modulation	Increased EVM at higher symbol rates
– Digital Standard IS-95 CDMA R&S SMIQB42	IQ filter 850 kHz is missing
– Digital Standard WCDMA R&S SMIQB43, Digital Standard WCDMA 3GPP (FDD) R&S SMIQB45, Enhanced Functions for Digital Standard WCDMA 3GPP (FDD) R&S SMIQB48	Increased EVM
– Arbitrary Waveform Generator R&S SMIQB60	–
– Fading Simulators R&S SMIQB14/15	–
– Noise Generator/Distortion Simulator R&S SMIQB17	–
– Amplitude modulation	Not possible with option R&S SMIQB57
– Level setting, attenuator mode electronic	Not possible with option R&S SMIQB57
– Level setting, ALC OFF, MODE TABLE	Not possible with option R&S SMIQB57

## Ordering information

Vector Signal Generator	R&S SMIQ03HD	1125.5555.33
<b>Accessories supplied</b>		
Power cable, operating manual		

## Options

High ACLR for WCDMA 3GPP (2110 MHz to 2170 MHz)	R&S SMIQB57 <sup>1)</sup>	1105.1831.02
---	---------------------------	--------------

<sup>1)</sup> Factory installation only.

For all other options/recommended extras/application software please refer to the data sheet of the R&S SMIQ (PD 0757.2438).

## Additional hints

R&S SMIQ03HD can be equipped with up to three of the following options: R&S SM-B5, R&S SMIQB14, R&S SMIQB15, R&S SMIQB17 and R&S SMIQB57.

R&S SMIQB47 cannot be fitted into the R&S SMIQ03HD (the I/Q filters 2.5 MHz, 5 MHz, 7.5 MHz and 10 MHz for High ACLR are fitted as standard in the R&S SMIQ03HD, the 850 kHz I/Q filter is omitted.)

